

USER MANUEL



**Speakers monitoring
Studio and Home-studio**

Pro5 V3 – Pro8 V3 – Pro10s V3



Precaution

Thank you for purchasing this digital appliance. To ensure perfect operation and security, please read the manual carefully and retain it for future reference.

Safety Precautions



The lightning flash with the arrowhead symbol in an equilateral triangle is intended to alert the user to the presence of non-insulated “dangerous voltage” inside the appliance that may be of sufficient magnitude to constitute a risk of electric shock.



The exclamation point within an equilateral triangle is intended to alert the user to the presence of important operating and maintenance (servicing) instructions in the literature accompanying the product.

Important Safety Instructions



(Figure 1)

- 1) Read these instructions.
- 2) Retain these instructions.
- 3) Heed all warnings.
- 4) Follow all instructions.
- 5) Do not use this appliance near water.
- 6) Clean only with a dry cloth.
- 7) Do not block any of the ventilation openings that were installed in accordance with the manufacturer’s instructions.
- 8) Do not install near any heat sources such as radiators, heat registers, stoves, or other appliances (including amplifiers) that produce heat.
- 9) Do not defeat the safety purpose of the polarized or grounding-type plug. A polarized plug has two blades with one wider than the other. A grounding type plug has two blades and a third grounding prong. The wide blade or the third prong is provided for your safety. If the plug provided does not fit into your outlet, consult an electrician to ensure replacement of the obsolete outlet.
- 10) Protect the power cord from being walked on or pinched, particularly at plugs, convenience receptacles, and the point where it exits from the appliance.
- 11) Only use attachments/accessories specified by the manufacturer.
- 12) Use only with the cart, stand, tripod, bracket, or table specified by the manufacturer, or sold with the appliance. If using a cart, be careful when moving the cart/appliance combination to avoid injury from tip-over (Figure 1).
- 13) Unplug this appliance during lightning storms or when unused for long periods of time.
- 14) Refer all servicing to qualified service personnel. Servicing is required when the appliance has been damaged in any way, for example, the power-supply cord or plug is damaged, liquid has been spilled or objects have fallen inside the appliance, the appliance has been exposed to rain or moisture, does not operate normally, or has been dropped.

WARNING: To reduce the risk of fire or electric shock, do not expose this appliance to rain or moisture.

CAUTION: The appliance should not be exposed to drips or splashes of water. Objects filled with liquids, such as vases, should not be placed on the appliance.

Contents

1 – Introduction	1
2 – Connections	2
3 - Settings.....	3
4 – Audio Inputs/Outputs	4
5 – Monitor Layout.....	5
6 - Specifications	6
7 – Response curve	7

1 – Introduction

We would like to thank you for having chosen our PRODIPE products.

Safety Precautions

For your security and for the correct implementation of this product, please read the safety precautions on the inside cover page.

Caution, if you want to reduce the risk of being electrocuted, do not remove the rear panel on this product. Please contact your retailer or a qualified technician for any maintenance that needs to be carried out.

When the volume is high, this system can produce noise levels that could permanently damage your hearing.

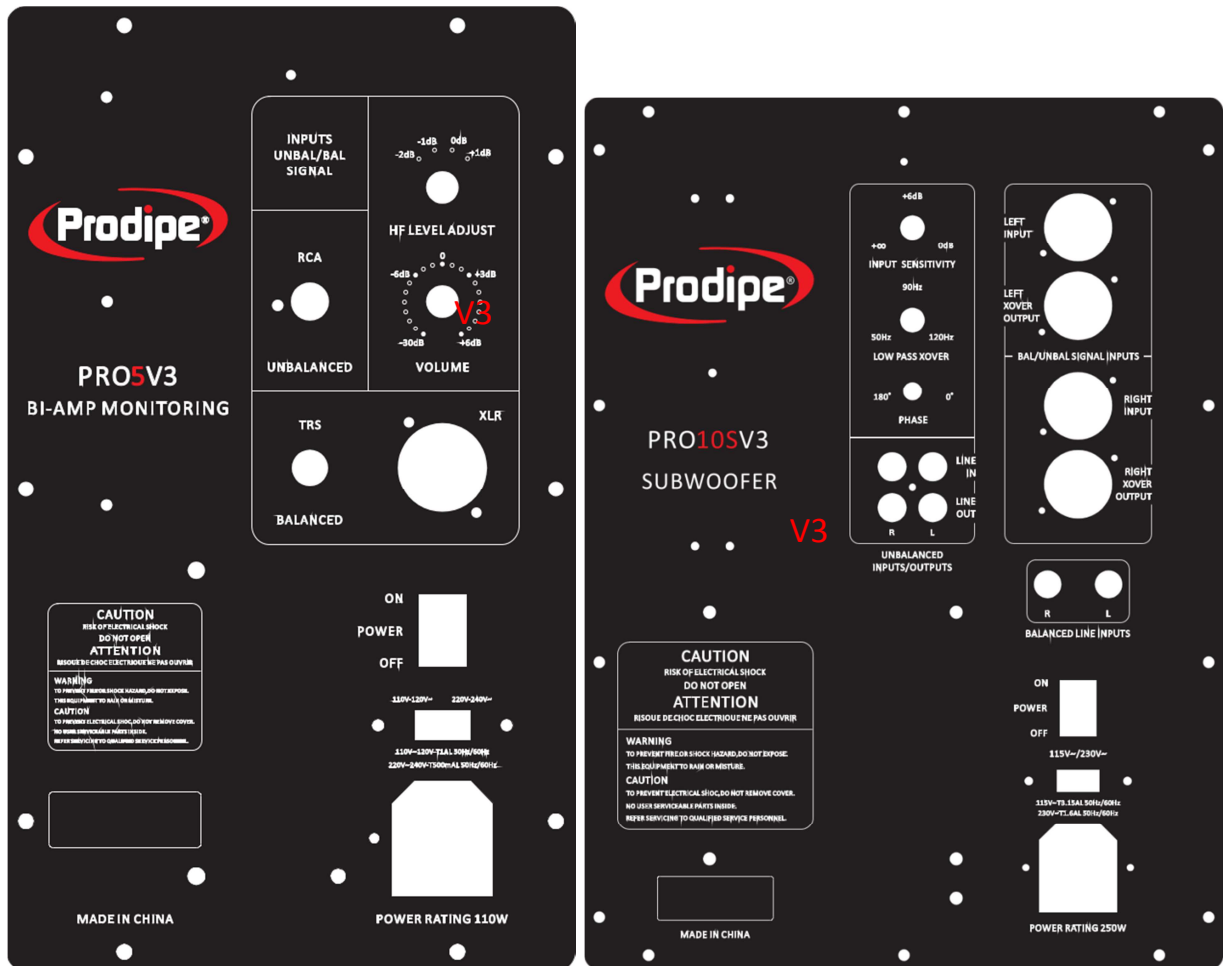

Figure 1 – Rear panels for Pro5 V3 / Pro8 V3 and the Pro10s V3

2 – Connections

To ensure the proper implementation of your monitor system, please adhere to the following procedures at all times:

1. Check your audio lead.
2. Switch on the other equipment you intend to use (audio mixer, PC, audio source, etc.)
3. Check your monitor settings and the settings of your audio sources (lowest volume).
4. Check the voltage (2), switch on the Prodipe monitors by putting switch (1) in the ON position and the blue LED ☉ will light up.

Note that: when you want to shut everything down, the Prodipe monitors must be switched off first, switch (1) in the OFF position and the blue LED (3) off.

Careful: choosing the "AC Select" (2) voltage depends on your power supply. You should make any changes when the system has been switched off, switch (1) in the OFF position and the power supply lead unplugged.

	Pro 5 V3		Pro 8 V3		Pro 10s V3	
SOURCE	100V – 120V	220V – 240V	100V – 120V	220V – 240V	100V – 120V	220V – 240V
AC SELECT (2)	115V	230V	115V	230V	115V	230V
FUSIBLE (4)	1A	500mA	2A	1A	3.15A	1.6A

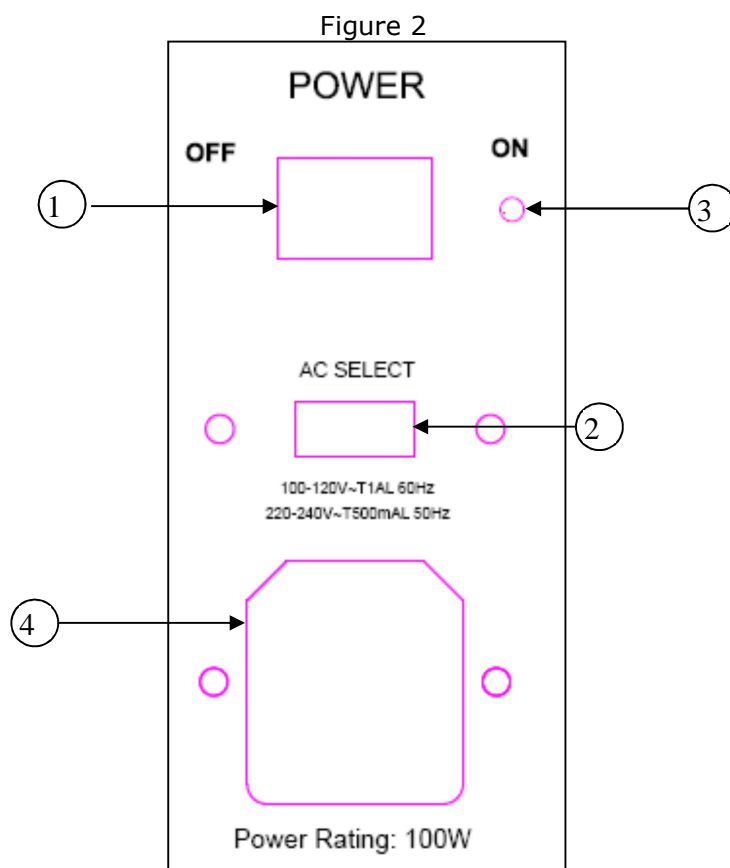

3 - Settings

There are different settings on the rear panels of your monitors:

VOLUME

You can adjust the gain setting at the back of the monitor using the changeover switch in Figure 3. It can be set from -30dB to +6dB.

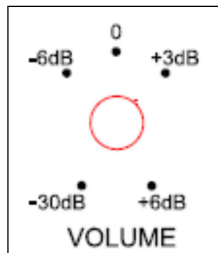

Figure 3

ADJUSTING THE HIGH FREQUENCIES (HF LEVEL) – Pro5 v3 and Pro8 v3 only

You can adjust the high frequencies at the back of the monitor (Figure 4). The possible values are -2dB, -1dB, 0dB (flat), 1dB, or at around 2 kHz. The crossover frequency between the tweeter and the woofer is 3KHz (Pro5 V3) and 2.4KHz (Pro8 V3).

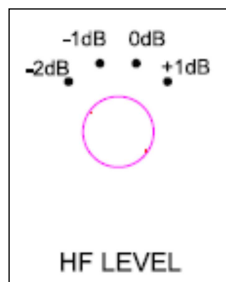

Figure 4

ADJUSTING OF THE LOW-PASS FILTER - Pro10s V3 only

By adjusting the low-pass filter you can set the high cutoff frequency so that the performance of the subwoofer is optimised relative to your front speakers. The subwoofer audio outputs that connect to your speakers rely on a high-pass filter to ensure that any subwoofer infrasound is eliminated.

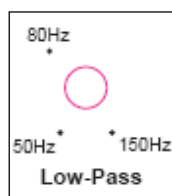

Figure 5



PHASE ROTATION - Pro10s V3 only

By setting the phase switch to either 0° or 180° you should be able to perfectly synchronise the subwoofer with the woofers from your front speakers. Try the phase switch at 0°, then at 180°, over a wide range of musical styles, and choose the setting which produces the strongest bass. Generally, the switch should be set to 0°, which is the default value.

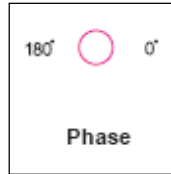

Figure 6

4 – Audio Inputs/Outputs

The XLR and TRS connectors are balanced whilst the RCA connectors are unbalanced.

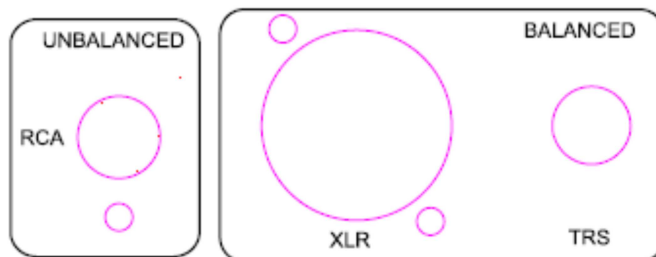

Figure 7 – TRS, XLR and RCA inputs for Pro5 V3 and Pro8 V3

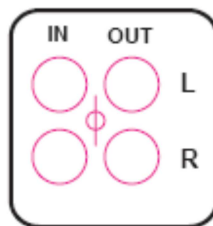

Figure 8 – RCA inputs/outputs for the Pro10S V3 Subwoofer

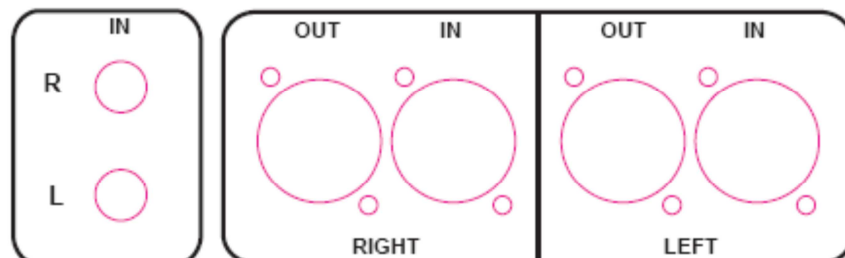

Figure 9 – TRS, XLR inputs/outputs for the Pro10SV3 Subwoofer



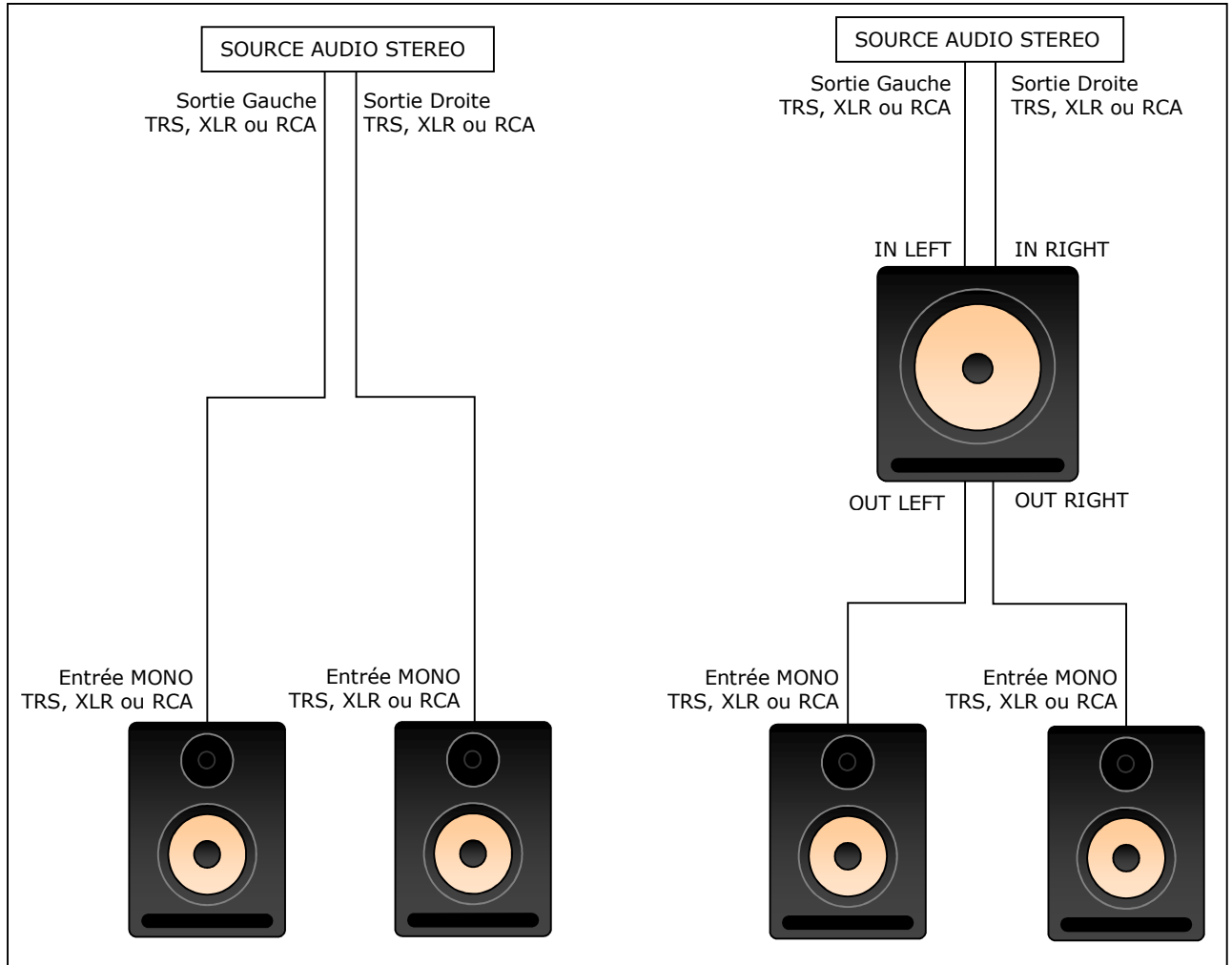

Figure 10 – Stereo connections with/without subwoofer

5 – Monitor Layout

The Prodipe studio monitors can be placed in a vertical or horizontal position.

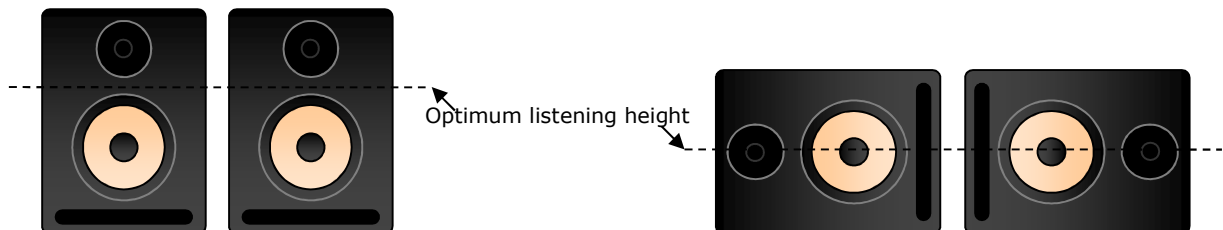
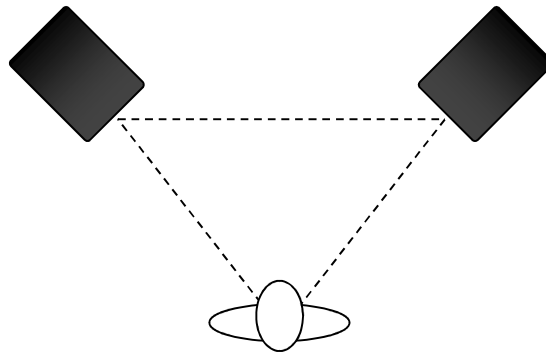

Figure 11



Positioning in Stereo

We recommend that you respect the layout of this diagram i.e. the equilateral triangle showing the optimum positions for you and your speakers, as much as possible. In addition, the speakers should be turned towards the listener. On a final note, you should try the sub bass woofer in a number of positions to determine which position gives the highest level of volume.



Best stereo listening position

Figure 12

When designing a studio layout, the positioning of the monitors is of the utmost importance. Reflection is the most common acoustics problem.

As shown in Figure 13, the position of a monitor in relation to an audio mixer can change the sound waves and hence distort how you perceive your sound production.

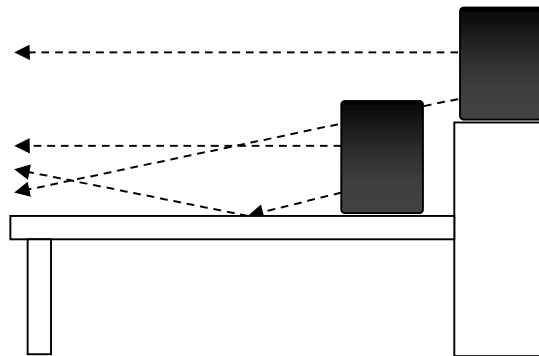

Figure 13

We have provided the angles and the distance ratios for your information based on studies from sound engineers. Nevertheless, the room acoustics themselves might be such that this information is not always accurate and therefore the best way to optimize your configuration.



6 - Specifications

	Pro5 V3	Pro8 V3	Pro10s V3
FREQUENCY REPOSE	55Hz -22KHz	50Hz -22KHz	36Hz -150Hz
HF DRIVER	1" (25mm) Neodymium soft dome	1" (25mm) Neodymium soft dome	
LF DRIVER	5.25" (130mm) Fiberglass cone	8" (200mm) Fiberglass cone	10" (250mm) long excursion Fiberglass cone
AMPLIFICATION HF RMS power (peak) LF RMS power (peak)	25W (40W) 50W (90W)	35W (55W) 90W (160W)	150W (270W)
NOISE RATIO (HF/LF) T.H.D. %(HF/LF)	82dB / 90dB 0.05% / 0.02%	86dB / 97dB 0.09% / 0.01%	98 dB 0.05%
INPUT IMPEDANCE Balanced Unbalanced	10KΩ 10KΩ	10KΩ 10KΩ	10KΩ 10KΩ
CROSSOVER FREQUENCY Crossover Frequency Subsonic Filter	3.0KHz 50Hz	2.4KHz 45Hz	
FUSE (5mm x 20mm) 100V - 120V 220V - 240V	1A 500mA	2A 1A	3.15A 1.6A
FEATURES	1 XLR Input 1 TRS Input 1 RCA Input IEC Main Connector VOLUME Control HF LEVEL Control LED Power Indicator	1 XLR Input 1 TRS Input 1 RCA Input IEC Main Connector VOLUME Control HF LEVEL Control LED Power Indicator	2 XLR Inputs and Outputs 2 TRS Inputs and Outputs 2 RCA Inputs and Outputs IEC Mains Connector VOLUME Control LOW-PASS Control Phase switch LED Power Indicator
DIMENSIONS (H x W x D) in mm	291 x 196 x 228	380 x 260 x 300	382 x 355 x 398
NET WEIGHT (per unit)	5.5Kg	13Kg	18Kg



7 – Response curve

Curve of Pro5 V3 speaker (dB SPL, resolution 1/12 d'octave):

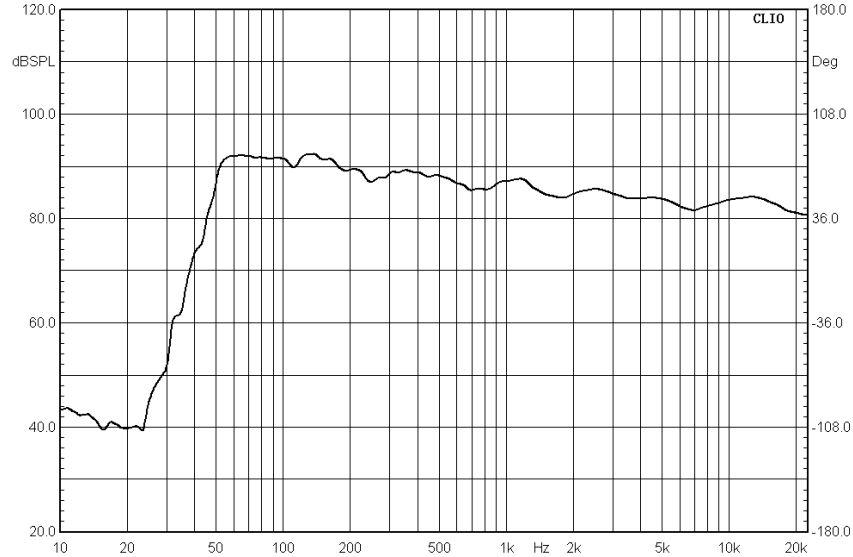

Curve of Pro10s V3 subwoofer (dB SPL, resolution 1/12 d'octave):

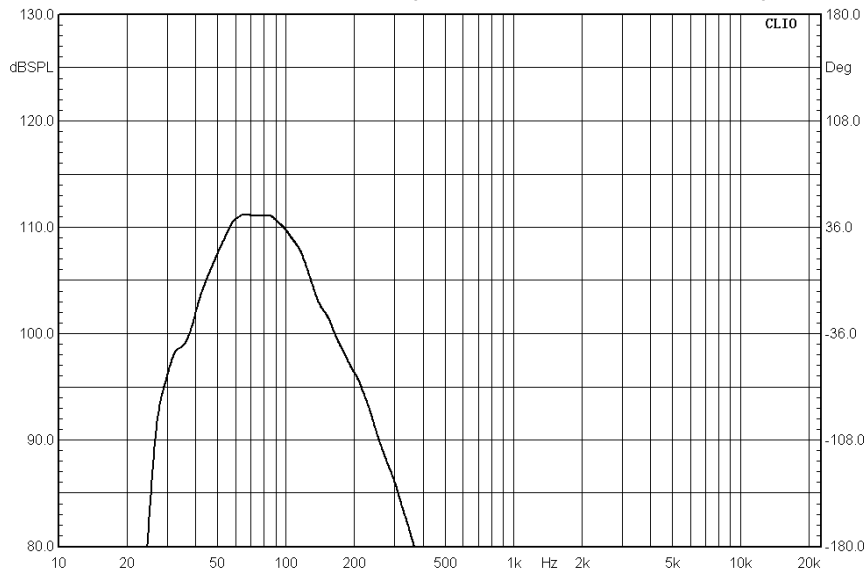



IPE Music

20, rue Clément ADER
Z.A. Les Gloriets
85340 OLONNE SUR MER
France

www.prodipe.com



Illustrations et photos non contractuelles

Copyright © 2015 IPE Music